

Product Group Chart

● Organic Conductive Polymer Capacitors (OP-CAP)

SMD Type

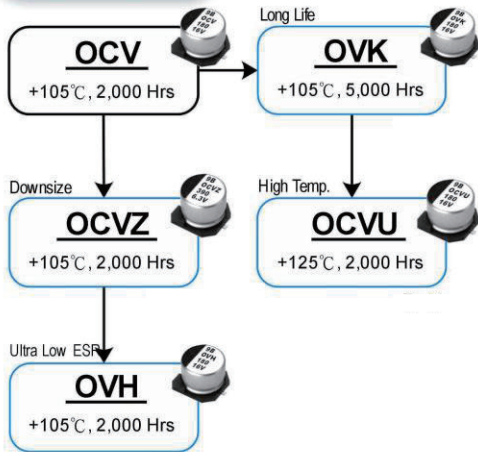

Radial Type

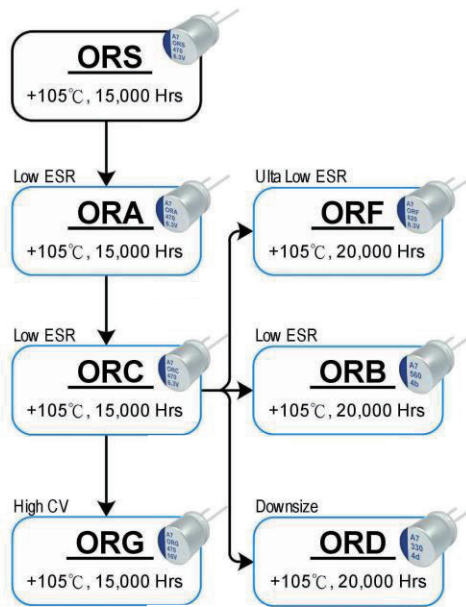
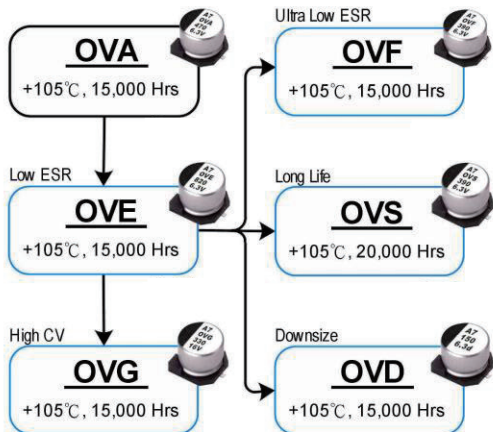
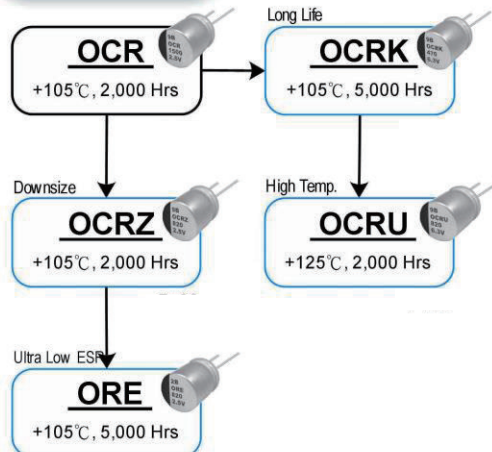

● Conductive Polymer Hybrid Capacitors

SMD Type



Radial Type

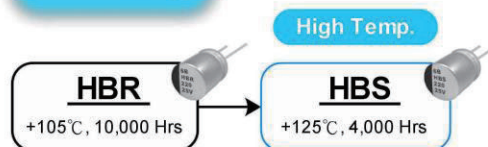

* Special application available upon request.

SMD Aluminum Electrolytic Capacitors

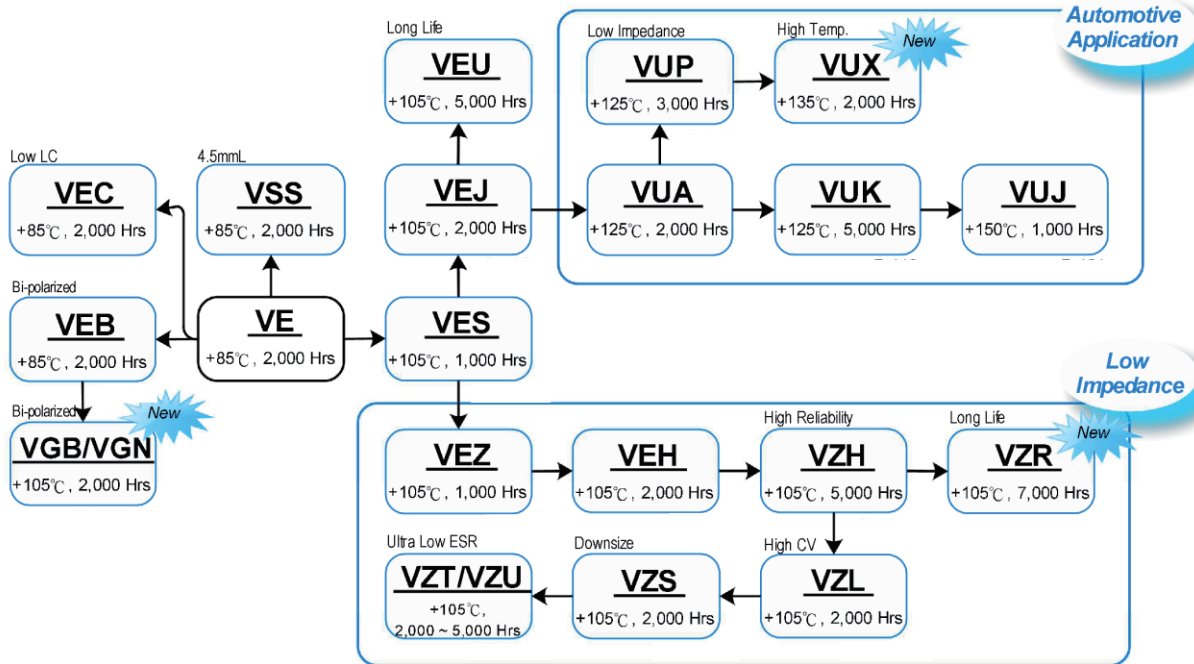

Radial Type

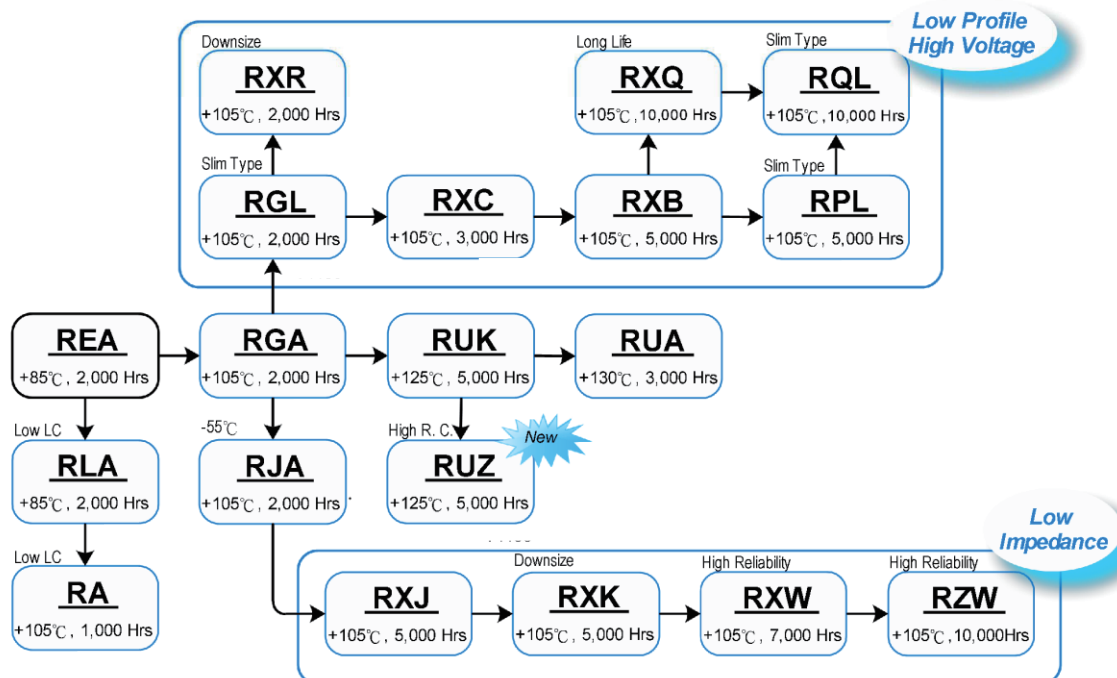

Flame Retardant

Snap-in Type



Radial Type



* Special application available upon request.

● Radial - 7mmL and 5mmL

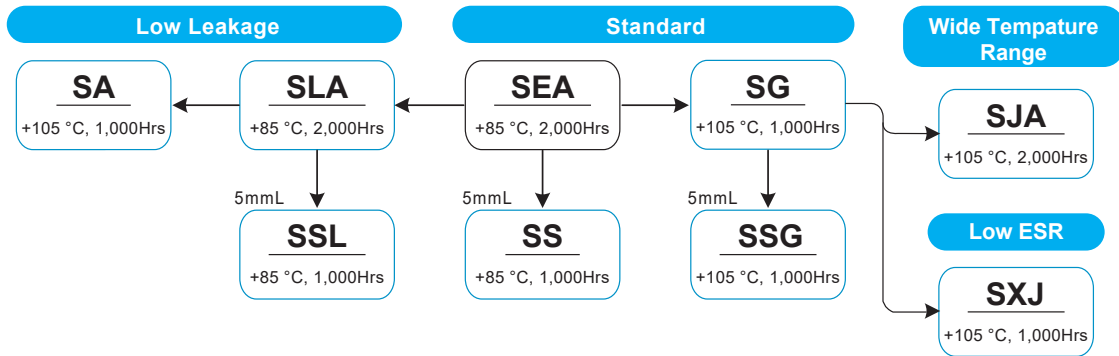

● Snap-in Terminal

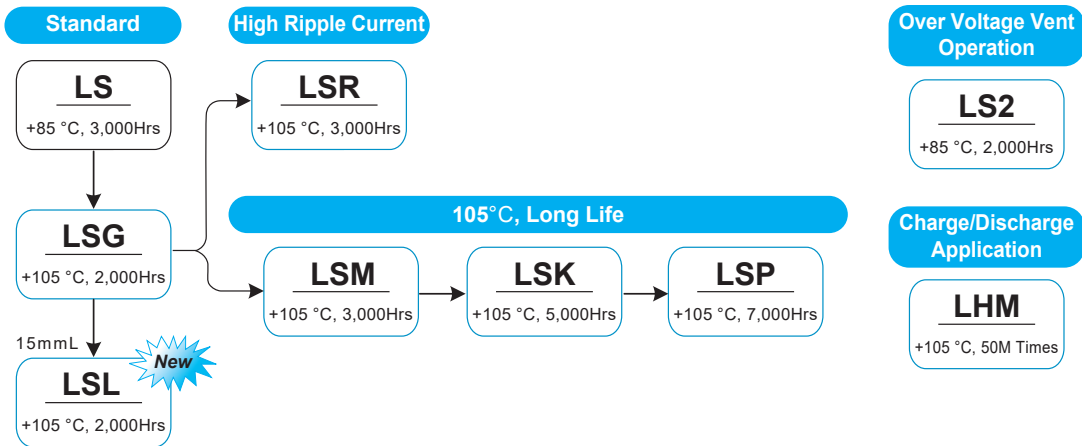

● Screw Terminal

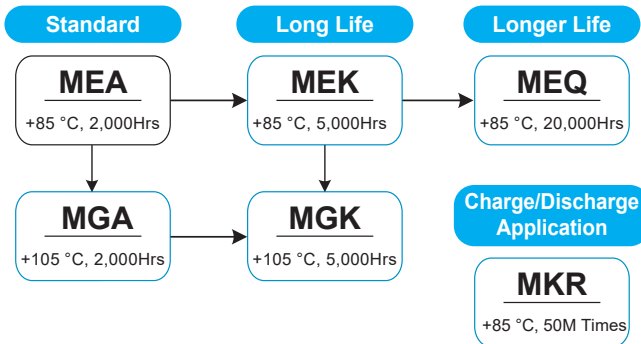

● Bi-polarized

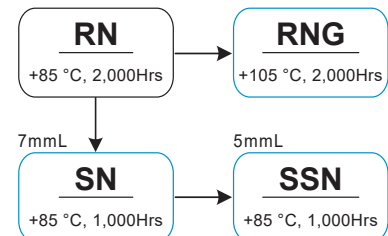

● Axial

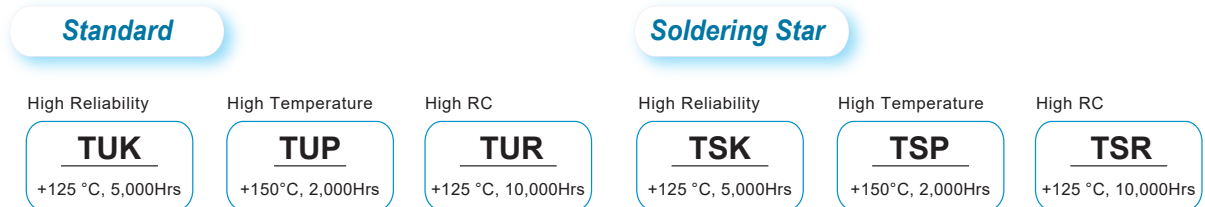

Note: Axial type is not included in this catalog.